

Circularly Polarized Conical Beam Formation by Backfire Helical Antennas

SAURA, Yasuo / YAMAUCHI, Junji / MIMAKI, Hiroaki /
NAKANO, Hisamatsu

(出版者 / Publisher)

Institute of Electronics, Information and Communication Engineers

(雑誌名 / Journal or Publication Title)

IEICE Transactions on Electronics / IEICE Transactions on Electronics

(号 / Number)

10

(開始ページ / Start Page)

3246

(終了ページ / End Page)

3252

(発行年 / Year)

1991-10-20

Circularly Polarized Conical Beam Formation by Backfire Helical Antennas

Hisamatsu NAKANO[†], Yasuo SAURA[†], Hiroaki MIMAKI[†]
and Junji YAMAUCHI[†], *Members*

SUMMARY A backfire helical antenna (BHA) is numerically analyzed to form a circularly polarized conical beam. The conical beam whose radiation is null in the helical axis direction is obtained using the second mode operation of the BHA. The characteristics of monofilar, bifilar and quadrifilar BHA's are compared and discussed. It is found that a second-mode bifilar BHA radiates a circularly polarized conical beam over a frequency range of 1 : 1.4. The use of the first mode of a bifilar BHA is also investigated to form a quasi-conical beam which has the weak radiation in the helical axis direction.

1. Introduction

In satellite communication, use of circular polarization eliminates the need for control of the antenna orientation about the bore-sight. In addition, for land mobile antennas, a circularly polarized conical beam is preferable since no satellite tracking system is required (see Fig. 1).

In previous studies, a circularly polarized conical beam was typically realized by a spiral antenna or a microstrip antenna operating in higher modes^{(1)–(3)}. These antennas have the advantage of low profile structure. However, when installation space is limited, a rod type of antenna is required.

One type of rod antenna which is capable of radiating a circularly polarized wave (CPW) is a

helical antenna. However, conventional forwardfire⁽⁴⁾ and backfire⁽⁵⁾ helices operating in the first mode (helix circumference is on the order of one wavelength or less) radiate an axial beam, a CPW towards the antenna axis, rather than a conical beam.

The purpose of this paper is to demonstrate the formation of a conical beam in the $-Z$ hemisphere shown in Fig. 1, using a backfire helical antenna (BHA). The radiation characteristics of the BHA are evaluated on the basis of the current distribution determined by the moment method.

First, we consider the generation of a conical beam using the second-mode operation (helix circumference is on the order of two wavelengths)^{(6),(7)}. After investigating the possibility of generating a conical beam by a monofilar BHA, shown in Fig. 2, we improve the symmetry of the radiation pattern by using a quadrifilar BHA, shown in Fig. 4. Furthermore, a symmetrical radiation pattern and a simple feeding system are realized by adopting a bifilar BHA, shown in Fig. 8. Finally, the formation of a quasi-conical beam is demonstrated using the first-mode operation of a bifilar BHA, shown in Fig. 14.

2. Numerical Method

To evaluate the radiation characteristics of thin wire antennas, knowledge of the current distribution along the antenna arm is of fundamental importance. The current distribution along the helical arm is calculated by the moment method^{(8),(9)}. On the basis of the determined current distribution, the radiation characteristics, including the radiation pattern, axial ratio and gain, are evaluated.

The monofilar BHA and the second-mode bifilar BHA are excited with a small ground plane. In these analyses, the small ground plane is approximated by a wire grid model. The wire radius of the modelled ground plane is taken to be the same as that of the helix proper.

3. Possibility of Generating a Conical Beam by a Monofilar BHA

Figure 2 shows the configuration of a monofilar BHA. A single helical wire is excited with a δ -function

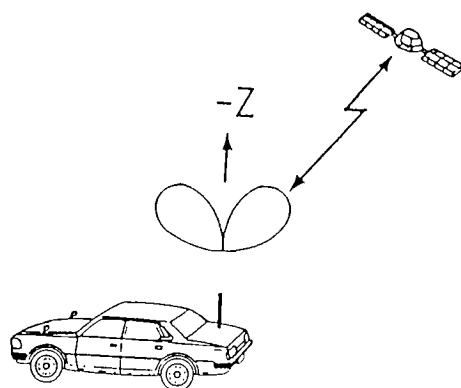

Fig. 1 Satellite communication system using a conical beam antenna.

Manuscript received April 8, 1991.

[†] The authors are with College of Engineering, Hosei University, Koganei-shi, 184 Japan.

generator between the short wire connected to the helix proper and the small ground plane. The following designations are used to specify the configuration of the BHA.

- C_H : circumference of the helical cylinder
- D_H : diameter of the helical cylinder
- α : pitch angle
- n : number of helical turns
- a : wire radius
- C_G : circumference of the small ground plane
- D_G : diameter of the small ground plane

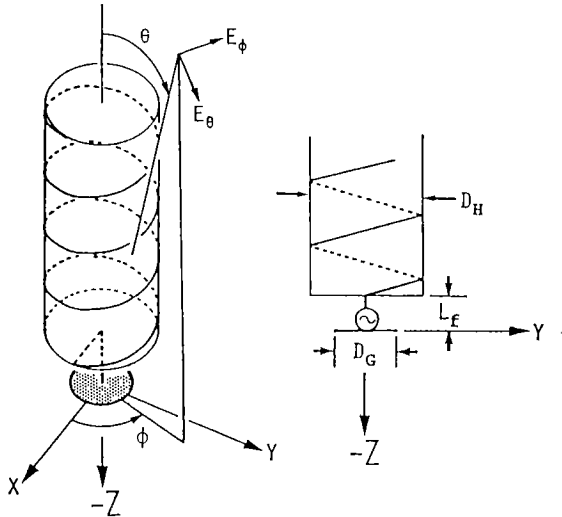

Fig. 2 Configuration of a monofilar BHA.

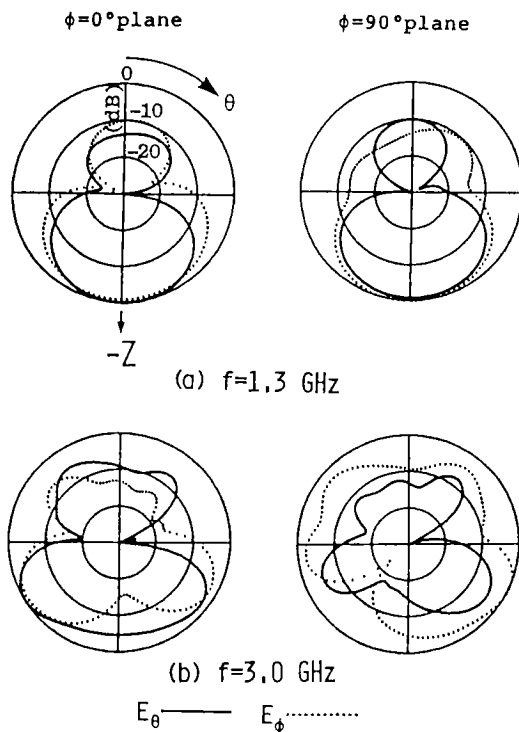

Fig. 3 Radiation pattern for a monofilar BHA.

L_f : short wire length for feeding

In this section, the configuration parameters are taken to be $C_H=18.96$ cm, $\alpha=12.5^\circ$, $n=4$, $a=0.05$ cm, $D_G=2$ cm, $L_f=0.64$ cm. The circumferences of the helical cylinder normalized to the operating frequency are 0.82 at 1.3 GHz and 1.90 at 3.0 GHz.

Figure 3 shows representative examples of the calculated radiation patterns at 1.3 GHz and 3.0 GHz. The patterns are shown in the two principal planes, $\phi=0^\circ$ and $\phi=90^\circ$. It is found that backfire radiation occurs when C_H is about one wavelength, and that the radiation pattern splits into two beams when C_H is about two wavelengths.

The helix can be approximated by a succession of loops, where the electrical loop size changes with frequency. The traveling wave current distributions on the loops of one- and two-wavelength circumference, determined numerically, allow us to easily interpret the difference in radiation patterns.

Although the possibility of generating a conical beam with the monofilar BHA is demonstrated, the asymmetry of the radiation pattern, which is caused by the single-arm configuration, is appreciable, as can be seen from Fig. 3. To obtain a more symmetrical pattern, we must use a multiple-arm configuration, as described in the next section.

4. A Conical Beam from a Second-Mode Quadrifilar BHA

Complete symmetry of the radiation patterns in the $\phi=0^\circ$ and $\phi=90^\circ$ planes can be obtained by using a quadrifilar BHA.

Figure 4 illustrates the configuration and the feeding geometry of a quadrifilar BHA. The small ground plane, required for feeding in the monofilar BHA, is not needed in the quadrifilar BHA. Instead, two individual exciters must be used, as shown in Fig. 4.

The circumference of the helix C_H , the pitch angle α and the wire radius " a " are $C_H=1.896\lambda_3$ (λ_3 is the free-space wavelength at 3 GHz), $\alpha=12.5^\circ$ and $a=0.005\lambda_3$, respectively. The number of helical turns is n

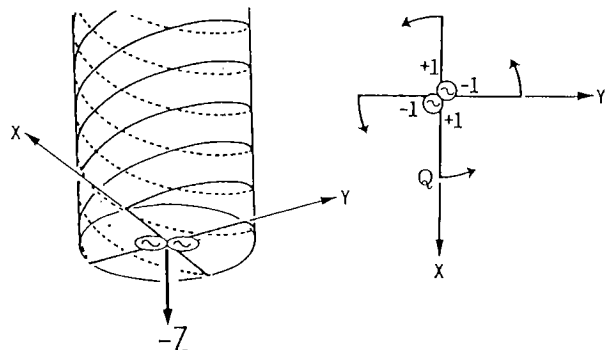

Fig. 4 Configuration of a quadrifilar BHA.

$=4$, which gives an antenna height of $1.7\lambda_3$.

Figure 5 shows the frequency characteristic of the current amplitude distribution. A traveling wave is dominant along the helical arm over a wide frequency range.

Figure 6 shows the frequency characteristic of the radiation pattern. Since identical patterns are obtained in the $\phi=0^\circ$ and $\phi=90^\circ$ planes, only the pattern in the $\phi=0^\circ$ plane is presented. A circularly polarized conical beam is formed in the $-Z$ hemisphere.

Figure 7 shows the gain and axial ratio characteristics, together with the angle of maximum radiation, θ_{max} . A CPW with an axial ratio of less than 1 dB is generated over a frequency range of 2.5 GHz to 3.75 GHz (1 : 1.5). The frequency range in which the variation of the gain is within ± 1.5 dB is evaluated to be about 36%.

Although the quadrifilar BHA forms a conical beam over a wide range of frequencies, the feeding system is complicated because of the multiple arms. The next consideration is, therefore, given to a bifilar BHA.

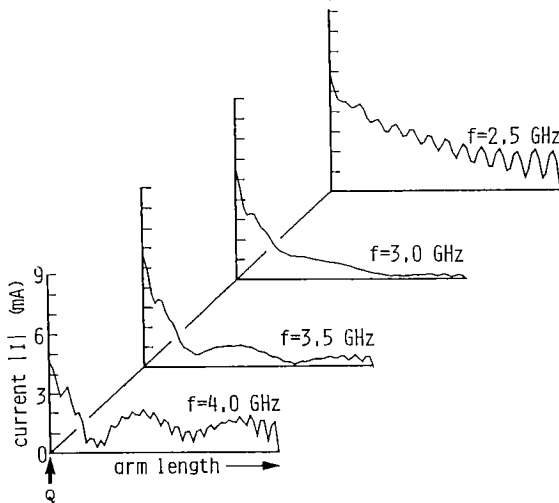

Fig. 5 Current distribution vs. frequency for a quadrifilar BHA.

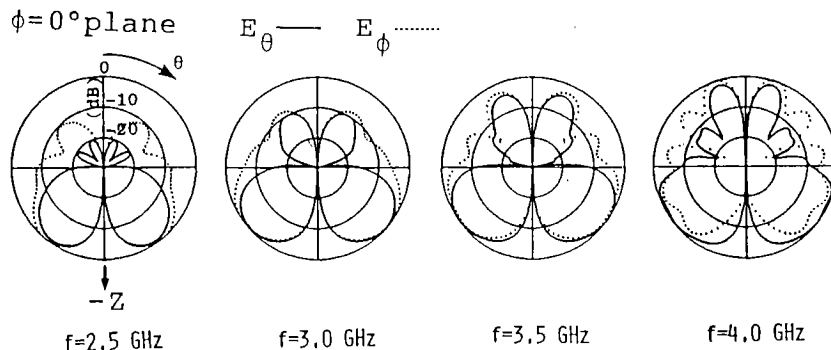

Fig. 6 Radiation pattern vs. frequency for a quadrifilar BHA.

5. A Conical Beam from a Second-Mode Bifilar BHA

Figure 8 shows the configuration of a second-mode bifilar BHA. The two arms are combined at point P for in-phase excitation. A ground plane is used

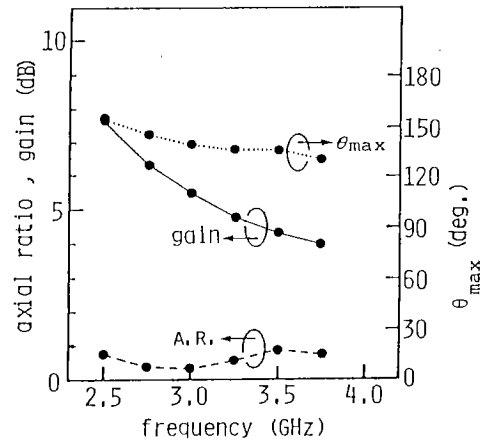

Fig. 7 Radiation characteristics vs. frequency for a quadrifilar BHA.

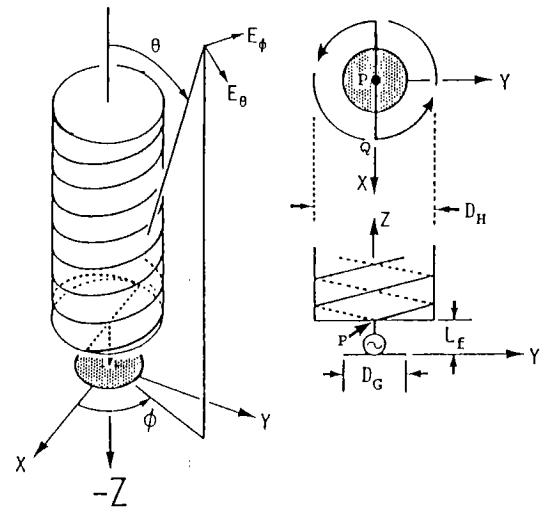

Fig. 8 Configuration of a bifilar BHA.

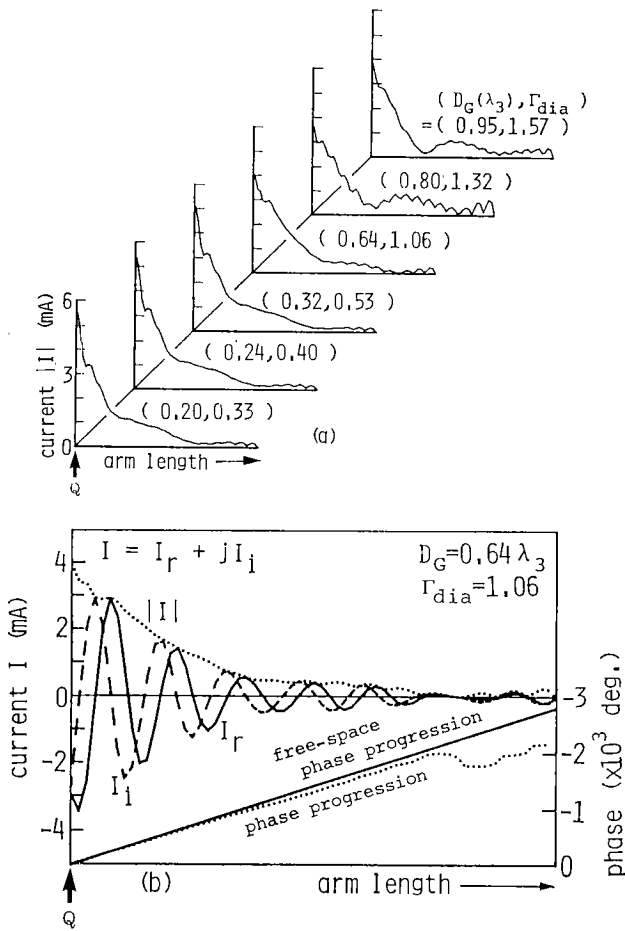

Fig. 9 Current distribution as a function of the ground plane diameter D_G for a bifilar BHA.

at the feed point to simplify the feeding system. The configuration parameters are chosen to be the same as those for the second-mode quadrifilar BHA.

The size of the ground plane affects the form of the current distribution. When the diameter of the ground plane D_G is small, compared with that of the helical cylinder D_H , a decaying traveling wave current dominates along the helical arm. This current supports backfire radiation. On the other hand, when the ground plane is large, a surface wave current is generated, resulting in forwardfire radiation.

The behavior of the current distribution as a function of the ground plane diameter is shown in Fig. 9(a), where the operating frequency is taken to be 3.0 GHz. In this analysis, the ratio of D_G to D_H ($\Gamma_{dia} = D_G/D_H = C_G/C_H$) is in a range of 0.33 to 1.57. As a typical example, the complex current distribution ($I_r + jI_i$) for $\Gamma_{dia} = 1.06$ is presented in Fig. 9(b).

Detailed calculations show that the current distribution smoothly decays provided that the Γ_{dia} is less than 1.25. The phase progression of the decaying current is close to that in free space. The decaying current generates backfire radiation, as shown in Fig. 10. When the Γ_{dia} is larger than 1.25, a surface wave current

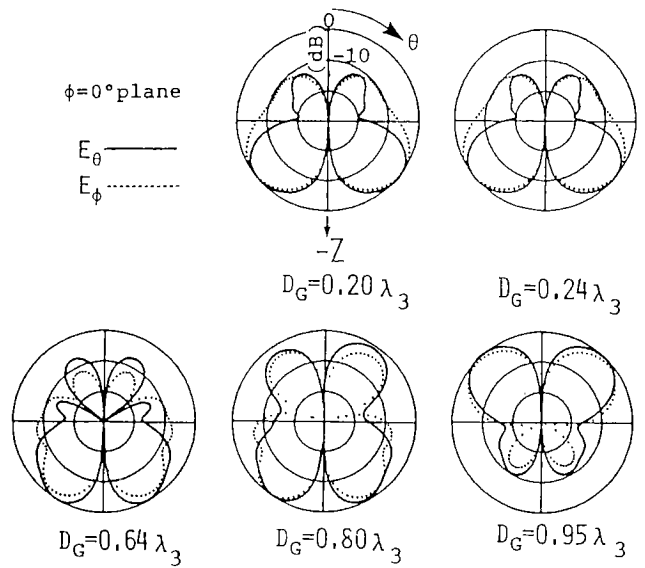

Fig. 10 Radiation pattern as a function of the ground plane diameter D_G for a bifilar BHA.

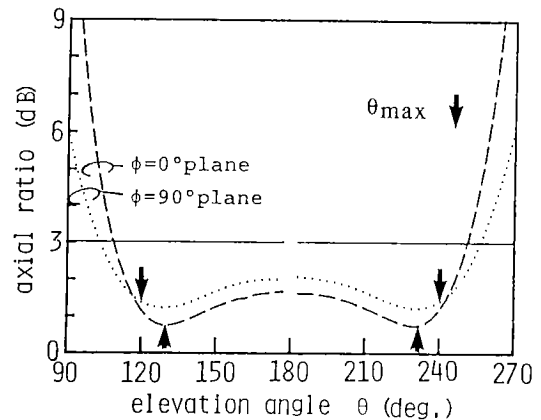

Fig. 11 Axial ratio characteristic vs. angle θ for a bifilar BHA.

appears in addition to the decaying current⁽¹⁰⁾.

The axial ratio characteristic for $D_G = 0.24 \lambda_3$ as a function of the angle θ is shown in Fig. 11. For the $\phi = 0^\circ$ plane, an excellent CPW with an axial ratio of less than 3 dB is obtained over a wide angle range from $\theta = 111^\circ$ to 249° . Note that there is no radiation at $\theta = 180^\circ$. The axial ratio at the maximum radiation angle is calculated to be 0.72 dB. A similar axial ratio characteristic is also observed for the $\phi = 90^\circ$ plane.

Now we consider the frequency characteristics of the bifilar BHA. Since our discussion is focused on backfire radiation, we fix the diameter of the ground plane to be $D_G = 0.24 \lambda_3$, which corresponds to $\Gamma_{dia} = 0.4$, and vary the frequency from 2.3 GHz to 4.0 GHz.

Figure 12 shows the frequency characteristic of the current amplitude distribution. A decaying current distribution is observed at 3.0 GHz. At frequencies lower than 3.0 GHz, a standing wave appears, because of the current reflected towards the feed point due to insufficient attenuation of the traveling wave.

Figure 13 demonstrates that the second-mode bifilar BHA can radiate a circularly polarized conical beam with an axial ratio of less than 3 dB over a frequency range of 2.5 GHz to 3.5 GHz (1 : 1.4). At frequencies higher than 3.0 GHz, a surface wave current appears. This leads to an increase in the forwardfire radiation, with subsequent deterioration of the back-to-front ratio of the radiation pattern.

6. A Quasi-Conical Beam from a First-Mode Bifilar BHA

Finally, consideration is given to the formation of a quasi-conical beam from a bifilar BHA operating in the first mode, without a ground plane, as shown in

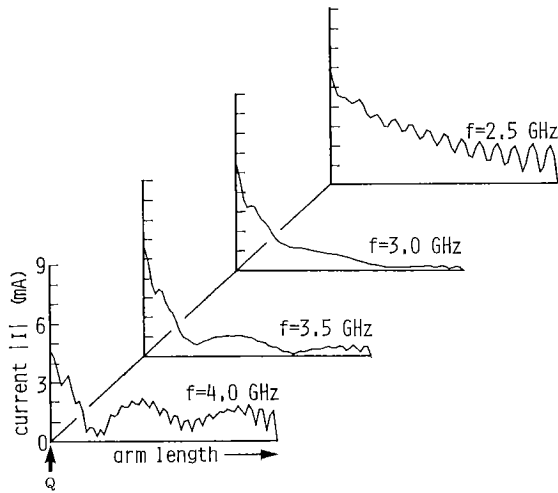

Fig. 12 Current distribution vs. frequency for a bifilar BHA.

Fig. 14. Usually, the bifilar BHA operating in the first mode radiates an axial beam⁽⁵⁾. It should be noted, however, that a quasi-conical beam (which does not have null radiation in the helical axis direction) is expected, when the circumference and the pitch angle are taken to be about 0.3 wavelengths and 60 degrees, respectively. The quasi-conical beam operation was experimentally found by Patton in 1962⁽⁶⁾.

This type of BHA has an advantage that the circumference is small compared with those of BHA's operating in the second mode. However, it requires a long antenna height to support enough attenuation of

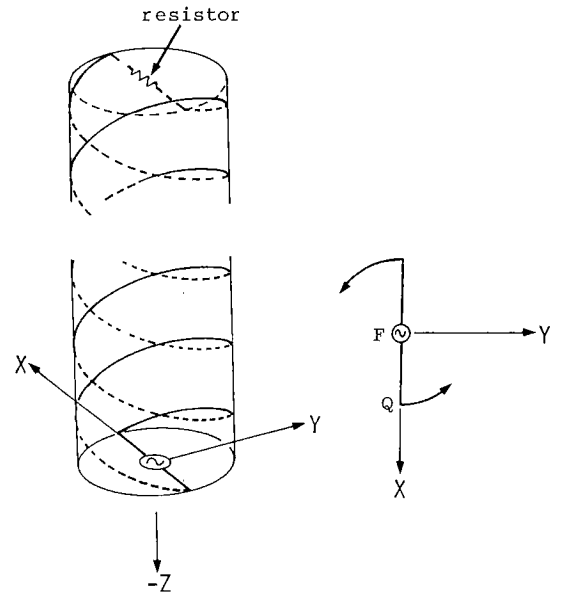

Fig. 14 Configuration of a first-mode bifilar BHA.

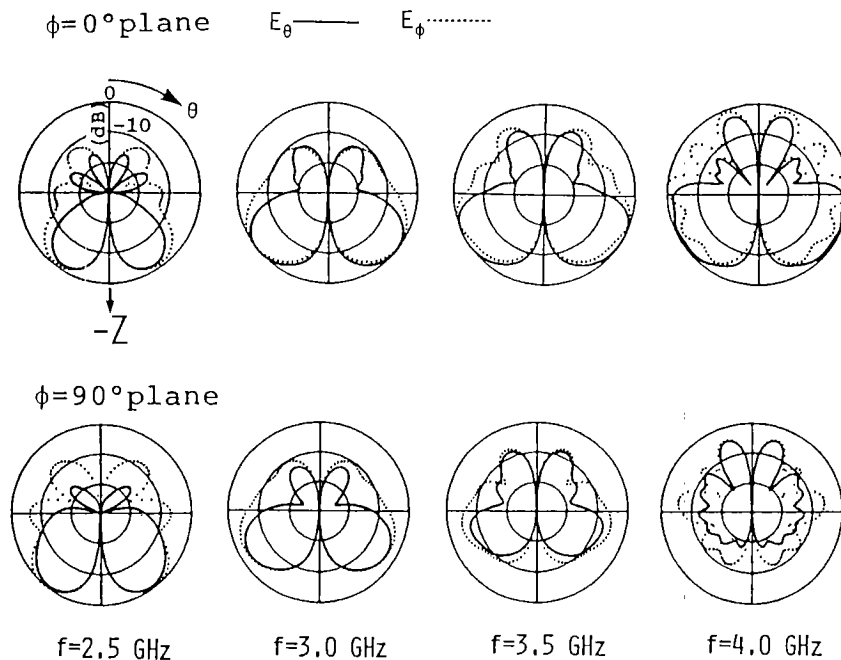

Fig. 13 Radiation pattern vs. frequency for a bifilar BHA.

the current⁽¹¹⁾. To reduce the antenna height, we adopt a means of terminating the arm ends with a proper resistor⁽¹²⁾, as shown in Fig. 14.

Figure 15 shows the current distribution of the bifilar BHA whose arm ends are connected with a resistor of 400 Ω. The number of helical turns is $n=3$, which corresponds to a 1.9-wavelength height. Other configuration parameters are as follows. The circumference $C_H=0.335\lambda_3$, the pitch angle $\alpha=62.5^\circ$ and the wire radius $a=0.0027\lambda_3$.

By virtue of the addition of the resistor, the traveling wave flows along the helical arm. This supports backfire radiation, as shown in Fig. 16. Although some amount of power is dissipated in the resistor, the gain obtained in the direction of the maximum radiation is calculated to be 4.8 dB, which is comparable to that of the quadrifilar BHA discussed in Sect. 5.

The axial ratio evaluated in the direction of the maximum radiation is 1.0 dB. A circularly polarized wave with an axial ratio of less than 3 dB is obtained over a wide angle coverage θ from 96° to 153° and from 207° to 264° in the $\phi=0^\circ$ plane, and from 93° to 153° and from 207° to 267° in the $\phi=90^\circ$ plane.

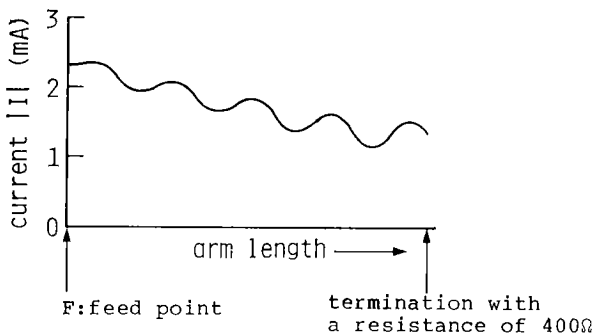

Fig. 15 Current distribution of a first-mode bifilar BHA.

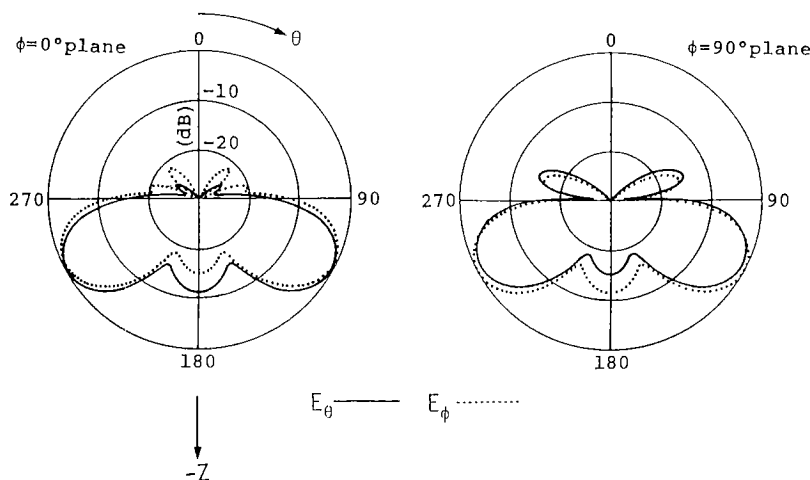

Fig. 16 Radiation pattern of a first-mode bifilar BHA.

7. Conclusions

Formation of a circularly polarized conical beam by backfire helical antennas (BHA) has been demonstrated with numerical results. The radiation characteristics of the BHA's are calculated from the current distributions determined by the moment method.

Consideration is first given to the generation of a conical beam using the second mode. After investigating the possibility of generating a conical beam by a monofilar BHA, a quadrifilar BHA is analyzed to achieve a more symmetrical pattern. It is found that the quadrifilar BHA radiates a circularly polarized conical beam over a wide frequency range from 2.5 GHz to 3.75 GHz (1 : 1.5) for a 1 dB axial ratio criterion.

To simplify the antenna configuration and the feeding system, while maintaining a symmetrical pattern, detailed consideration is given to a second-mode bifilar BHA with a ground plane. Numerical results reveal that the second-mode bifilar BHA radiates a circularly polarized conical beam over a frequency range from 2.5 GHz to 3.5 GHz (1 : 1.4) for a 3 dB axial ratio criterion.

The formation of a quasi-conical beam is also demonstrated using a bifilar BHA operating in the first mode, without a ground plane. To reduce the antenna height, we adopt a means of terminating the arm ends with a proper resistor. The first-mode BHA has an advantage that the circumference of the helix is small compared with that of the second-mode BHA.

Frequency characteristics of the first-mode bifilar BHA are yet to be researched.

Acknowledgment

The authors would like to thank Mr. Victor Shkawrytko for his assistance in the preparation of this paper.

References

- (1) Nakano H., Yamauchi J. and Hashimoto S.: "Numerical analysis of 4-arm Archimedean spiral antenna", *Electron Lett.*, **19**, 3, pp. 78-80 (1983).
- (2) Huang J.: "Circularly polarized conical pattern from circular microstrip antennas", *IEEE Trans. Antennas & Propag.*, **AP-32**, 9, pp. 991-994 (1984).
- (3) Nakano H., Vichien K., Sugiura T. and Yamauchi J.: "Singly-fed patch antenna radiating a circularly polarised conical beam", *Electron. Lett.*, **26**, 10, pp. 638-640 (1990).
- (4) Kraus J. D.: "Antennas", McGraw-Hill (1988).
- (5) Patton W. T.: "The backfire bifilar helical antenna", *Univ. of Illinois, Antenna Lab. Rept.*, 61 (1962).
- (6) Nakano H., Saura Y., Takeda A. and Yamauchi J.: "Backfire helical antennas", *IEICE Technical Report*, **AP88-60** (1988).
- (7) Nakano H., Mimaki H. and Yamauchi J.: "Generation of a circularly polarised conical beam from backfire helical antennas", 1991 ICAP York, UK, pp. 42-45 (1991)
- (8) Harrington R. F.: "Field computation by moment methods", MacMillan (1968).
- (9) Nakano H.: "Helical and spiral antennas—a numerical approach", Research studies press (1988).
- (10) Nakano H., Yamauchi J. and Mimaki H.: "Backfire radiation from a monofilar helix with a small ground plane", *IEEE Trans. Antennas & Propag.*, **36**, 10, pp. 1359-1364 (1988).
- (11) Terada N. and Kagoshima K.: "Conical-beam radiation pattern performance of bifilar helix antenna", 1991 Spring Natl. Conv. Rec., IEICE, B-43.
- (12) Nakano H., Iio S. and Yamauchi J.: "Frequency characteristics of tapered backfire helical antenna with loaded termination", *IEE Proc. Part H*, **131**, 3, pp. 147-152 (1984).

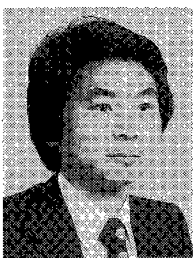

Hisamatsu Nakano was born in Ibaraki, Japan, on April 13, 1945. He received the B. E., M. E., and Dr. E. degrees in electrical engineering from Hosei University, Tokyo, in 1968, 1970, and 1974, respectively. Since 1973, he has been a member of the faculty of Hosei University, where he is now a Professor of Electrical Engineering. His research topics are numerical methods for microwave antennas and scattering problems.

He has published more than 100 refereed papers on antenna problems, and is the author of a book entitled "Helical and spiral antennas (Research Studies Press, Wiley)." He was a Visiting Associate Professor at Syracuse University (May to September, 1981), where he worked on numerical analysis of electromagnetic coupling between wires and slots; a Visiting Professor at University of Manitoba (March to September, 1986) researching numerical techniques for analysis of microstrip antennas; and a Visiting Professor at University of California, Los Angeles (September, 1986 to March, 1987) working on microstrip line antenna analysis. While in Canada he was a recipient of an international scientific exchange award from the Natural Sciences and Engineering Research Council of Canada. In 1987 he received the Best Paper Award of the IEE Fifth International Conference on Antennas and Propagation. Dr. Nakano is a Senior Member of the IEEE.



Yasuo Saura was born in Tochigi, Japan, on December 13, 1964. He received the B. E. and M. E. degrees from Hosei University, Tokyo, Japan, in 1987 and 1989, respectively. He joined the TOKIMEC INC., Tokyo, in 1989.



Hiroaki Mimaki was born in Yamaguchi, Japan, on December 7, 1952. He received the B. E. degree in electrical engineering from Tokyo Denki University, Tokyo, in 1976 and the M. E. degree in electrical engineering from Hosei University, Tokyo, in 1981. He is currently an assistant at Hosei University. His research interests are in thin wire antennas.



Junji Yamauchi was born in Nagoya, Japan, on August 23, 1953. He received the B. E., M. E., and Dr. E. degrees in electrical engineering from Hosei University, Tokyo, in 1976, 1978, and 1982, respectively. From 1984 to 1988, he served as a Lecturer at Tokyo Metropolitan Technical College. Since 1988, he has been a member of the Faculty of Hosei University, where he is an Associate Professor of Electrical Engineering.

His research interests include circularly polarized antennas and waveguides. Dr. Yamauchi is a member of the IEEE and the Optical Society of America.